 a size for every space

DISCOVER NEW SIZES IN  
OUR BEST-SELLING SOFAS.

POTTERY BARN

# FURNITURE GUIDE

CARLISLE COLLECTION

# POTTERY BARN

CARLISLE COLLECTION



Our Carlisle Collection pairs a laid-back deep seat and down blend wrapped cushions with the distinctive presence of a traditional English roll arm. With a design worthy of its own niche, the collection accommodates both relaxed gatherings and special occasions.

Built using eco-friendly materials, this responsibly sourced upholstered collection features:

- Springs constructed using partially recycled steel
- Deluxe seat cushions feature a hypoallergenic down-blend wrap over 15% soy-based foam. Back cushions contain a deluxe hypoallergenic down-blend fill
- Kiln-dried hardwood frames

The Carlisle Collection is created with the same attention to quality, detail and durability that's been the hallmark of American-made furniture for hundreds of years. Built to last by expert craftsmen at our Sutter Street shop in Hickory, North Carolina, each piece in the collection undergoes six quality control checkpoints where every component is inspected to ensure the highest standard of quality.

In addition to comfort and structural integrity, the Carlisle Collection offers unmatched versatility. Each piece can be easily customized with your choice of upholstery or slipcovers available in over 80 fabrics and colors.

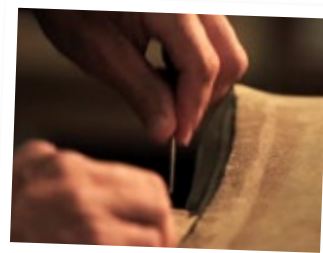

PROUDLY MADE IN  
**AMERICA**

BY OUR OWN MASTER CRAFTSMEN



WE'VE EXPANDED OUR FAVORITE UPHOLSTERY COLLECTIONS TO HAVE MORE SIZES & STYLES AVAILABLE:

- Three sofa sizes offered: love seat, sofa and grand sofa.
- More sectional configuration options than ever.
- Sofas and love seats available with a single bench cushion option.

## SOFAS

### STANDARD SEAT CUSHIONS



70" LOVE SEAT



80" SOFA



90.5" GRAND SOFA

### SINGLE BENCH CUSHION



70" LOVE SEAT



80" SOFA



90.5" GRAND SOFA

## CHAIRS & OTTOMAN



ARMCHAIR



SWIVEL ARMCHAIR



CHAISE



OTTOMAN

The Carlisle Collection is available as upholstered or slipcovered.

POTTERY BARN  
CARLISLE COLLECTION

SECTIONALS



LEFT/RIGHT SOFA WITH CHAISE SECTIONAL



LEFT/RIGHT 3-PIECE SECTIONAL  
WITH CORNER



3-PIECE L-SHAPED SECTIONAL WITH CORNER

The Carlisle Collection is available as upholstered or slipcovered.

BUILD-YOUR-OWN SECTIONAL



ARMLESS CHAIR



LEFT-ARM CHAIR



RIGHT-ARM CHAIR



ARMLESS LOVE SEAT



LEFT-ARM LOVE SEAT



RIGHT-ARM LOVE SEAT



LEFT-ARM CHAISE



RIGHT-ARM CHAISE



CORNER

The Carlisle Collection is available as upholstered or slipcovered.

# DESIGN YOUR SPACE

## FURNITURE SPECIFICATIONS

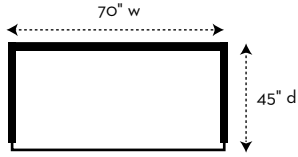

LOVE SEAT  
34" high

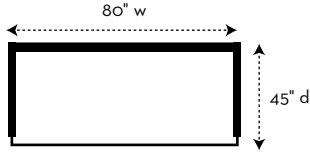

SOFA  
34" high

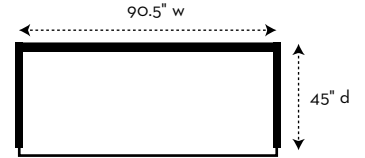

GRAND SOFA  
34" high

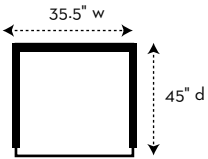

ARMCHAIR  
34" high

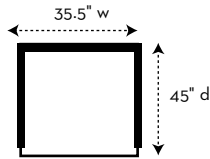

SWIVEL ARMCHAIR  
34" high

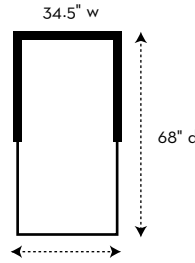

CHAISE  
34" high

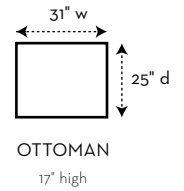

OTTOMAN  
17" high

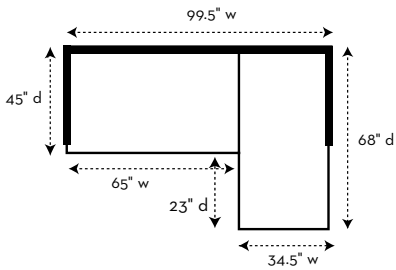

LEFT SOFA WITH CHAISE SECTIONAL  
34" high  
Consists of: Left Arm Love Seat, Right Arm Chaise

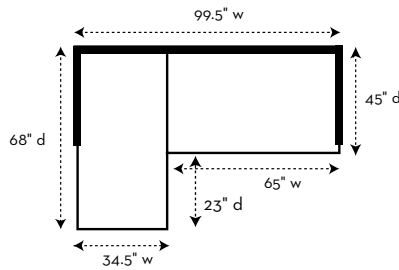

RIGHT SOFA WITH CHAISE SECTIONAL  
34" high  
Consists of: Right Arm Love Seat, Left Arm Chaise

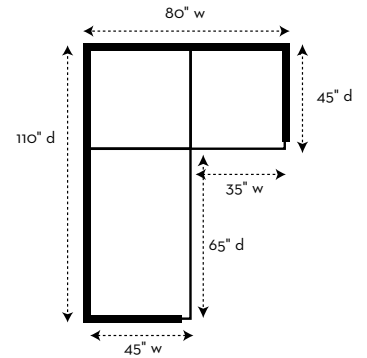

LEFT 3-PIECE SECTIONAL WITH CORNER  
34" high  
Consists of: Left Arm Love Seat, Corner, Right Arm Chair

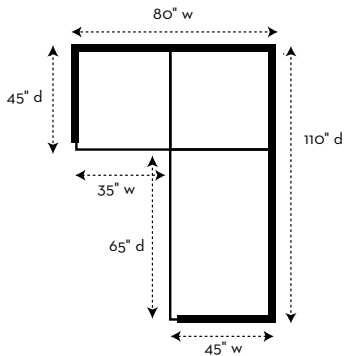

RIGHT 3-PIECE SECTIONAL WITH CORNER  
34" high  
Consists of: Right Arm Love Seat, Corner, Left Arm Chair

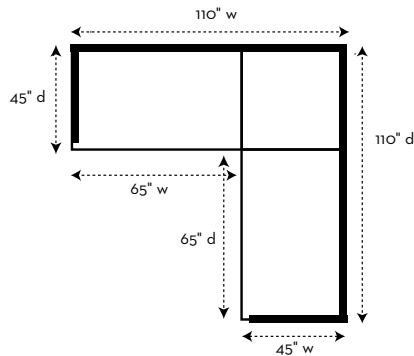

3-PIECE L-SHAPED SECTIONAL WITH CORNER  
34" high  
Consists of: Right Arm Love Seat, Corner, Left Arm Love Seat

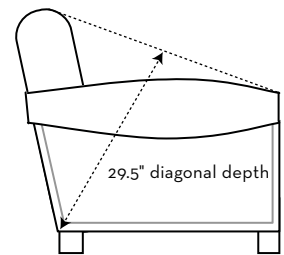

### DIAGONAL DEPTH

Diagonal depth is helpful when determining if a piece can be brought in on its end.

BUILD-YOUR-OWN-SECTIONAL  
COMPONENTS

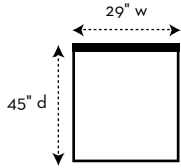

ARMLESS CHAIR  
34" high

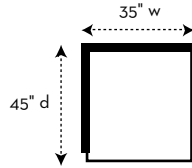

LEFT-ARM CHAIR  
34" high

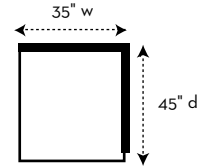

RIGHT-ARM CHAIR  
34" high

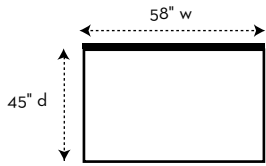

ARMLESS LOVE SEAT  
34" high

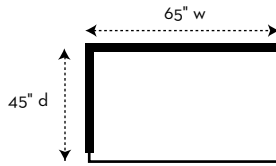

LEFT-ARM LOVE SEAT  
34" high

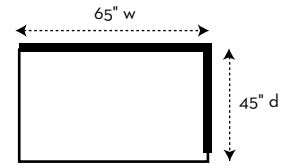

RIGHT-ARM LOVE SEAT  
34" high

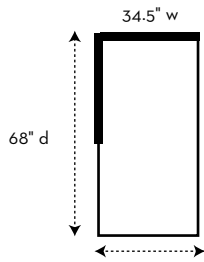

LEFT-ARM CHAISE  
34" high

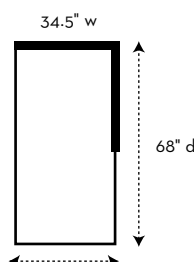

RIGHT-ARM CHAISE  
34" high

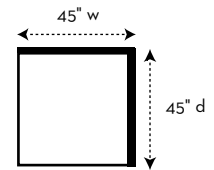

CORNER  
34" high

## 3 STEPS TO PREPARE FOR SUCCESSFUL FURNITURE DELIVERY

### DELIVERY DIMENSIONS. DOES IT FIT INTO MY HOME?

Before purchasing large furniture, it's a must to take proper measurements of your space to ensure that the piece will not only sit comfortably in the room for which it is intended, but also fit through all of the passageways between the delivery truck and your new furniture's final destination. Use the measuring guidelines below for a successful delivery:

#### 1 MEASURE YOUR SPACE

Identify the space in the room where you intend your piece to sit. Using painter's tape, mark out the dimensions on the floor. Does it fit? Is the scale right for the room? You can also create a floor plan using our online room planner.

Visit [potterybarn.com](http://potterybarn.com) and search: *room planner*

#### 2 COMPARE THE DIMENSIONS OF YOUR RESIDENCE AND YOUR FURNITURE PIECE

Consider the furniture to be delivered and determine if it can go straight through entryways or if it will have to go in at an angle or on its end.

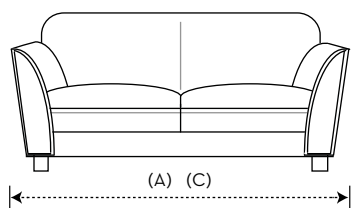

Sofa width must be less than entryway dimensions A or C.

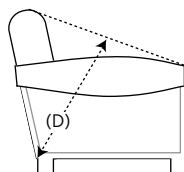

#### DIAGONAL DEPTH

Diagonal depth must be less than entryway dimension B. Diagonal depth is helpful when determining if the piece can be brought in on its end.

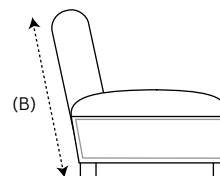

#### ARMLESS PIECE

For any piece that does not have arms (such as a wedge), do not use diagonal depth measurement. Instead, be certain that the back height measurement is less than the door width (B).

#### 3 MEASURE ALL DOORWAYS, PASSAGES & STAIRWELLS

Measure the interior height and width of every doorway, staircase, elevator and hallway that the item will pass through. Also consider architectural details and low hanging fixtures as you measure.

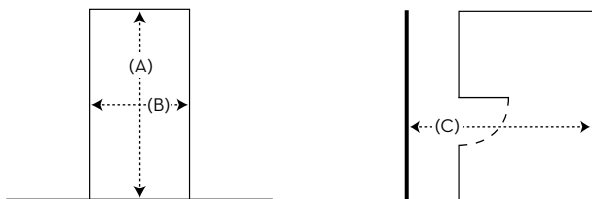

We take great pride in our outstanding customer service and our in-home delivery service. In order to ensure complete satisfaction, please take the time to measure carefully before purchasing, and contact a Pottery Barn customer service representative with any additional questions. 1.888.779.5176 / [customerservice@potterybarn.com](mailto:customerservice@potterybarn.com)



# POTTERY BARN

CARLISLE COLLECTION

## PERFORMANCE FABRICS

We know life happens. That's why we created each offering in our exclusive Performance Fabrics Collection to stand up to the rigors of reality – and time. Crafted to last, these high-quality, family-friendly fabrics are as durable as they are beautiful – and feel as great as they look. Water-repellent, easier to clean, fade- and abrasion-resistant, our Performance Fabrics are available at a great value, from Grade A through Grade E.



### ALL POTTERY BARN PERFORMANCE FABRICS ARE:

- Easy to spot clean and/or machine washable
- Water repellent
- Child- and pet-friendly
- Crafted to endure years of active use

### PERFORMANCE EVERYDAYVELVET GRADE A

Warp-knit velvet with a soft, plush pile.  
Content: 100% polyester face



### PERFORMANCE CANVAS GRADE B

Features superior hand-feel and drape. Stain resistant.  
Content: 100% polyester



### PERFORMANCE TWEED GRADE C

Woven with extra-soft chenille bouclé yarns. Stain resistant.  
Content: 100% polyester



### PERFORMANCE EVERYDAYSUEDE™ GRADE C

Ultraplush, soft-as-suede microfiber, finished in Italy.  
Content: 100% polyester face



### PERENNIALS® PERFORMANCE BASKETWEAVE GRADE E

A linen-look weave with a soft hand-feel. Stain resistant.  
Content: 100% Solution Dyed Acrylic



### PERENNIALS® PERFORMANCE AWNING STRIPE GRADE E

A bold striped linen-look weave with a soft hand-feel. Stain resistant.  
Content: 100% Solution Dyed Acrylic



POTTERY BARN  
CARLISLE COLLECTION  
FABRIC GUIDE

To best suit your needs and lifestyle, customize your sofa or sectional by choosing from over 80 fabrics. Free swatches are available to help you select just the right color and fabric. Need help? Contact a Design Specialist for free one-on-one design services at 1-800-922-5507, or go to your nearest store.

*free*  
FABRIC SWATCHES

All of our upholstery fabric swatches are complimentary and ship for free. Go to potterybarn.com to place an order, stop by one of our stores or call 1.800.922.5507.

GRADE A FABRICS

TWILL

A classic, woven solid in pure cotton.

- 100% cotton
- Made in the USA or Imported
- Slipcover Care: Our slipcovers are washable in your home washing machine. To wash, remove slipcovers and close all zippers and openings before loading into machine, dividing into smaller loads if necessary. Use gentle cycle, cold water and mild liquid detergent without bluing agents or bleach. Tumble dry on low until slightly damp. Remove promptly to reduce wrinkling and stretch slipcover back on frame and/or cushion(s) to complete drying.
- Upholstery Care: Spot clean with a damp white cloth. Blot to remove excess water. Air dry; or consult a professional upholstery cleaner.



TEXTURED LINEN COTTON

Subtle texture on a simple weave made of all natural fibers.

- 73% cotton, 27% linen
- Made in the USA
- Slipcover Care: Our slipcovers are washable in your home washing machine. To wash, remove slipcovers and close all zippers and openings before loading into machine, dividing into smaller loads if necessary. Use gentle cycle, cold water and mild liquid detergent without bluing agents or bleach. Tumble dry on low until slightly damp. Remove promptly to reduce wrinkling and stretch slipcover back on frame and/or cushion(s) to complete drying.
- Upholstery Care: Spot clean with a damp white cloth. Blot to remove excess water. Air dry, or consult with a professional upholstery cleaner.



PERFORMANCE EVERYDAYVELVET

A long-wearing performance fabric with a soft sheen and plush pile.

- 100% polyester face
- Imported
- Water repellent
- Slipcover Care: Our slipcovers are washable in your home washing machine. To wash, remove slipcovers and close all zippers and openings before loading into machine, dividing into smaller loads if necessary. Use gentle cycle, cold water and mild liquid detergent without bluing agents or bleach. Tumble dry on low until slightly damp. Remove promptly to reduce wrinkling and stretch slipcover back on frame and/or cushion(s) to complete drying.
- Upholstery Care: Spot clean with a damp white cloth. Blot to remove excess water. Air dry; or consult a professional upholstery cleaner.



TEXTURED TWILL

A linen look on a classic twill weave.

- 96% polyester, 4% other fabric
- Imported
- Slipcover Care: Our slipcovers are washable in your home washing machine. To wash, remove slipcovers and close all zippers and openings before loading into machine, dividing into smaller loads if necessary. Use gentle cycle, cold water and mild liquid detergent without bluing agents or bleach. Tumble dry on low until slightly damp. Remove promptly to reduce wrinkling and stretch slipcover back on frame and/or cushion(s) to complete drying.
- Upholstery Care: Spot clean with a damp white cloth. Blot to remove excess water. Air dry, or consult with a professional upholstery cleaner.



## GRADE B FABRICS

### BRUSHED CANVAS

A straight weave with a cozy, sueded hand feel.

- 100% cotton
- Made in the USA
- Slipcover Care: Our slipcovers are washable in your home washing machine. To wash, remove slipcovers and close all zippers and openings before loading into machine, dividing into smaller loads if necessary. Use gentle cycle, cold water and mild liquid detergent without bluing agents or bleach. Tumble dry on low until slightly damp. Remove promptly to reduce wrinkling and stretch slipcover back on frame and/or cushion(s) to complete drying.
- Upholstery Care: Do not spot clean. Consult a professional upholstery cleaner.



### DENIM

A subtly textured, casual woven fabric.

- 100% cotton
- Made in the USA
- Due to small batch washing, this fabric will exhibit variation in shade.
- Slipcover Care: Our slipcovers are washable in your home washing machine. To wash, remove slipcovers and close all zippers and openings before loading into machine, dividing into smaller loads if necessary. Use gentle cycle, cold water and mild liquid detergent without bluing agents or bleach. Tumble dry on low until slightly damp. Remove promptly to reduce wrinkling and stretch slipcover back on frame and/or cushion(s) to complete drying.
- (WASHED INDIGO) Slipcover Care: Machine wash cold, gentle cycle with like colors, only non-chlorine bleach when needed. Tumble dry low. Warm iron as needed, or spot clean with a damp white cloth. Blot to remove excess water. Air dry.
- Upholstery Care: Spot clean with a damp white cloth. Blot to remove excess water. Air dry; or consult a professional upholstery cleaner.
- (WASHED INDIGO) Upholstery Care: Spot clean with a damp white cloth. Blot to remove excess water. Air dry; or consult with a professional upholstery cleaner. Note: Some color transfer is possible. Dry all spills thoroughly before use.



### RECYCLED COTTON

An ultrasoft cotten blend woven from recycled yarns.

- 70% cotton, 26% acrylic, 4% other fabric
- Made in the USA
- Slipcover Care: Our slipcovers are washable in your home washing machine. To wash, remove slipcovers and close all zippers and openings before loading into machine, dividing into smaller loads if necessary. Use gentle cycle, cold water and mild liquid detergent without bluing agents or bleach. Tumble dry on low until slightly damp. Remove promptly to reduce wrinkling and stretch slipcover back on frame and/or cushion(s) to complete drying.
- Upholstery Care: Spot clean with damp white cloth. Blot to remove excess water. Air dry, or consult with a professional upholstery cleaner.



### WASHED GRAINSACK

A textured weave with a natural look.

- 85% polyester, 15% linen
- Imported.
- Slipcover Care: Spot clean with a damp white cloth. Blot to remove excess water. Air dry. May be dry cleaned.
- Upholstery Care: Spot clean with a damp white cloth. Blot to remove excess water. Air dry; or consult a professional upholstery cleaner.



### PERFORMANCE CANVAS

Features superior hand-feel and drape.

- 100% polyester
- Imported
- Water repellent
- Stain resistant
- Slipcover Care: Our slipcovers are washable in your home washing machine. To wash, remove slipcovers and close all zippers and openings before loading into machine, dividing into smaller loads if necessary. Use gentle cycle, cold water and mild liquid detergent without bluing agents or bleach. Tumble dry on low until slightly damp. Remove promptly to reduce wrinkling and stretch slipcover back on frame and/or cushion(s) to complete drying.
- Upholstery Care: Spot clean with a damp white cloth. Blot to remove excess water. Air dry; or consult a professional upholstery cleaner.



## GRADE B FABRICS CONTINUED

### ORGANIC COTTON CANVAS

A heavyweight woven canvas in pure organic cotton.

- 100% organic cotton
- Imported.
- Slipcover Care: Our slipcovers are washable in your home washing machine. To wash, remove slipcovers and close all zippers and openings before loading into machine, dividing into smaller loads if necessary. Use gentle cycle, cold water and mild liquid detergent without bluing agents or bleach. Tumble dry on low until slightly damp. Remove promptly to reduce wrinkling and stretch slipcover back on frame and/or cushion(s) to complete drying.
- Upholstery Care: Spot clean with a damp white cloth. Blot to remove excess water. Air dry; or consult a professional upholstery cleaner.



### BELLA

An elegant signature floral print on a subtly textured weave.

- 100% cotton
- Imported.
- Slipcover Care: Spot clean with a damp white cloth. Blot to remove excess water. Air dry. May be dry cleaned.
- Upholstery Care: Spot clean with a damp white cloth. Blot to remove excess water. Air dry, or consult a professional upholstery cleaner.



## GRADE C FABRICS

### WASHED LINEN/COTTON

A tailored weave with a light, laid-back look.

- 55% linen / 45% cotton
- Imported
- Slipcover Care: Our slipcovers are washable in your home washing machine. To wash, remove slipcovers and close all zippers and openings before loading into machine, dividing into smaller loads if necessary. Use gentle

- cycle, cold water and mild liquid detergent without bluing agents or bleach. Tumble dry on low until slightly damp. Remove promptly to reduce wrinkling and stretch slipcover back on frame and/or cushion(s) to complete drying.
- Upholstery Care: Spot clean with a damp white cloth. Blot to remove excess water. Air dry; or consult a professional upholstery cleaner.



### PERFORMANCE EVERYDAYSUEDE™

A soft-as-suede, long-wearing performance fabric.

- 100% polyester face
- Imported
- Water repellent
- Slipcover Care: Our slipcovers are washable in your home washing machine. To wash, remove slipcovers and close all zippers and openings before loading into machine, dividing into smaller loads if necessary. Use gentle cycle, cold water and mild liquid detergent without bluing agents or bleach.

- Tumble dry on low until slightly damp. Remove promptly to reduce wrinkling and stretch slipcover back on frame and/or cushion(s) to complete drying.
- Upholstery Care: Spot clean with a damp white cloth. Blot to remove excess water. Air dry; or consult a professional upholstery cleaner.



## GRADE C FABRICS CONTINUED

### PERFORMANCE TWEED

A stylish and sturdy textured performance weave.

- 100% polyester
- Imported
- Water repellent
- Stain resistant
- Slipcover Care: Our slipcovers are washable in your home washing machine. To wash, remove slipcovers and close all zippers and openings before loading into machine, dividing into smaller loads if necessary. Use

gentle cycle, cold water and mild liquid detergent without bluing agents or bleach. Tumble dry on low until slightly damp. Remove promptly to reduce wrinkling and stretch slipcover back on frame and/or cushion(s) to complete drying. Upholstered Care: Spot clean with a damp white cloth. Blot to remove excess water. Air dry; or consult with a professional upholstery cleaner.

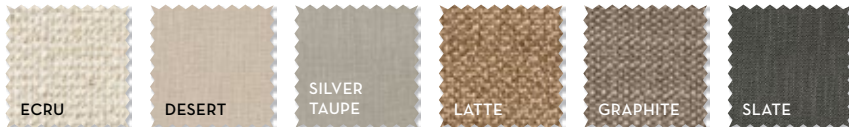

### CHUNKY HERRINGBONE

A highly textured fabric with a classic patterned weave.

- 76% cotton, 24% polyester
- Made in the USA
- Slipcover Care: Spot clean with a damp white cloth. Blot to remove excess water. Air dry. May be dry cleaned.
- Upholstery Care: Spot clean with a damp white cloth. Blot to remove excess water. Air dry; or consult with a professional upholstery cleaner.

### TEXTURED LINEN

A soft, chunky, textural weave.

- 100% linen
- Imported
- Slipcover Care: Dry clean only.
- Upholstery Care: Spot clean with damp white cloth. Blot to remove excess water. Air dry, or consult with a professional upholstery cleaner.



### LINEN

A subtly textured linen blend with a heavy drape.

- 57% linen, 43% cotton
- Imported
- Slipcover Care: Spot clean with a damp white cloth. Blot to remove excess water. Air dry. May be dry cleaned.
- Upholstery Care: Spot clean with a damp white cloth. Blot to remove excess water. Air dry; or consult with a professional upholstery cleaner.

### SATEEN TICKING STRIPE\*\*

An updated version of a classic stripe on a smooth, flat weave.

- 100% cotton
- Imported
- Slipcover Care: Dry clean. Can be spot cleaned with a damp white cloth. Blot to remove excess water. Air dry.
- Upholstery Care: Spot clean with a damp white cloth. Blot to remove excess water. Air dry; or consult with a professional upholstery cleaner.



### DOUBLE STRIPE\*\*

A casual stripe on a heavy, textured weave.

- 55% cotton, 45% linen
- Imported
- Slipcover Care: Dry clean. Can be spot cleaned with a damp white cloth. Blot to remove excess water. Air dry.
- Upholstery Care: Spot clean with a damp white cloth. Blot to remove excess water. Air dry; or consult with a professional upholstery cleaner.

### AMERICANA STRIPE

A vintage inspired multi-stripe.

- 100% cotton
- Slipcover Care: Our slipcovers are washable in your home washing machine. To wash, remove slipcovers and close all zippers and openings before loading into machine, dividing into smaller loads if necessary. Use gentle cycle, cold water and mild liquid detergent without bluing agents or bleach. Tumble dry on low until slightly damp. Remove promptly to reduce wrinkling and stretch slipcover back on frame and/or cushion(s) to complete drying.
- Upholstery Care: Spot clean with a damp white cloth. Blot to remove excess water. Air dry; or consult with a professional upholstery cleaner.



\*\*Not recommended on tufted products

## GRADE D FABRICS

### TEXTURED BASKETWEAVE

A linen blend with a tailored weave.

- 52% linen, 33% rayon, 15% cotton
- Imported
- Slipcover Care: Spot clean with a damp white cloth. Blot to remove excess water. Air dry. May be dry cleaned.
- Upholstery Care: Spot clean with a damp white cloth. Blot to remove excess water. Air dry; or consult a professional upholstery cleaner.



### VINTAGE VELVET

A rich, full pile velvet with an antiqued finish.

- 79% cotton, 21% polyester
- Made in the USA
- Slipcover Care: Dry clean only.
- Upholstery Care: Spot clean with damp white cloth. Blot to remove excess water. Air dry, or consult with a professional upholstery cleaner.



## GRADE E FABRICS

### PERENNIALS® PERFORMANCE BASKETWEAVE

A linen-look weave with a soft hand-feel.

- 100% Solution Dyed Acrylic
- Imported
- Water repellent
- Stain resistant
- Indoor/outdoor friendly - mold and fade resistant
- Slipcover Care: Our slipcovers are washable in your home washing machine. To wash, remove slipcovers and close all zippers and openings before loading into machine, dividing into smaller loads if necessary. Use gentle cycle, cold water and mild liquid detergent without bluing agents or bleach. Tumble dry on low until slightly damp. Remove promptly to reduce wrinkling and stretch slipcover back on frame and/or cushion(s) to complete drying.
- Upholstery Care: Spot clean with a damp white cloth. Blot to remove excess water. Air dry; or consult with a professional upholstery cleaner.



### PERENNIALS® PERFORMANCE AWNING STRIPE

A bold striped linen-look weave with a soft hand-feel.

- 100% Solution Dyed Acrylic
- Imported
- Water repellent
- Stain resistant
- Indoor/outdoor friendly - mold and fade resistant
- Slipcover Care: Our slipcovers are washable in your home washing machine. To wash, remove slipcovers and close all zippers and openings before loading into machine, dividing into smaller loads if necessary. Use gentle cycle, cold water and mild liquid detergent without bluing agents or bleach. Tumble dry on low until slightly damp. Remove promptly to reduce wrinkling and stretch slipcover back on frame and/or cushion(s) to complete drying.
- Upholstery Care: Spot clean with a damp white cloth. Blot to remove excess water. Air dry; or consult with a professional upholstery cleaner.



### BELGIAN LINEN

A pure linen with exceptional craftsmanship; grown and woven in Belgium.

- 100% Belgian Linen
- Made in Belgium
- Slipcover Care: Spot clean with a damp white cloth. Blot to remove excess water. Air dry. May be dry cleaned.
- Upholstery Care: Spot clean with a damp white cloth. Blot to remove excess water. Air dry; or consult with a professional upholstery cleaner.



Perennials® is a registered trademark of Perennials, Inc.

# POTTERY BARN

## UPHOLSTERED & SLIPCOVERED FURNITURE SHIPPING INFO

**IN-HOME DELIVERY** All of our upholstered furniture is delivered via our In-Home Delivery network. Most furniture items are opened and inspected prior to delivery to your home to ensure our quality expectations are met. On the day of delivery, we will bring the items into your home, place them in the room of your choice and complete any necessary assembly. Delivery is by appointment, Monday – Saturday; our delivery service will call to arrange a day and provide a 2–4 hour window for delivery. In-Home Delivery is available in the contiguous 48 states. Assembly is not available for headboard attachment to a non-Pottery Barn metal frame.

**QUICK SHIP: 1-3 WEEKS** Select items identified as Quick Ship will usually ship within 1 to 3 weeks for the cities shown on the map below. For other areas, your furniture will usually ship within 2 to 3 weeks.

**SPECIAL ORDER: 8-10 WEEKS** Special order items will usually ship within 8-10 weeks. We cannot accept returns on special order items. Please consider your order carefully.

### STANDARD SHIPPING CHARGES

For orders totaling	Include	For orders totaling	Include
up to \$15.00	\$4.95	\$90.01 to \$125.00	\$17.00
\$15.01 to \$25.00	\$6.00	\$125.01 to \$200.00	\$21.00
\$25.01 to \$45.00	\$8.00	\$200.01 & over	10%
\$45.01 to \$65.00	\$11.00	\$3,000.01 & over	NOW 5%
\$65.01 to \$90.00	\$14.00		

**ADDITIONAL SHIPPING AND DELIVERY SURCHARGES** Because furniture items are bulky, heavy and may have limited availability, these items have an additional delivery and processing surcharge. This charge is listed in parentheses (\$) after the item price and is in addition to regular delivery and processing charges, which are listed under Standard Shipping Charges.

**SALES TAX** Sales tax on the merchandise total is charged for items shipped to the following states, US territories and the District of Columbia: AL\*, AR\*, AZ, CA\*, CO\*, CT\*, DC\*, FL\*, GA\*, IA, ID, IL\*, IN\*, KS\*, KY\*, LA\*, MA, MD\*, ME\*, MI\*, MN\*, MO\*, MS\*, NC\*, ND\*, NE\*, NJ\*, NM\*, NV\*, NY\*, OH\*, OK, PA\*, RI\*, SC\*, SD\*, TN\*, TX\*, UT, VA\*, VT\*, WA\*, WI\*, WV\*, WY and Puerto Rico\*. States and US territories marked with an asterisk also collect taxes on shipping and processing charges. The local sales tax of the delivery destination is also charged. Sales tax for items shipped to Illinois is based on the location of final order acceptance. Orders delivered to California locations are F.O.B. destination point which means title passes in California.

**RETURNS** At Pottery Barn, we take great pride in the quality and craftsmanship of our products. Attention to design, materials and construction is our priority. We carefully inspect your order prior to shipment; upon receipt, please inspect your purchase and notify us of any damage. We will arrange for a prompt replacement. If, within 7 days for Quick Ship upholstery and 30 days for all other products, you are dissatisfied for any reason, you may return your purchase for a refund of the merchandise value. We cannot accept returns on special order items. Please consider your order carefully.

