



a size for every space

DISCOVER NEW SIZES IN
OUR BEST-SELLING SOFAS.

POTTERY BARN

FURNITURE GUIDE

TURNER SQUARE ARM LEATHER COLLECTION

POTTERY BARN

TURNER SQUARE ARM LEATHER COLLECTION



Supple leather lends an earthy warmth to this collection. The top-grain hide is meticulously dyed and burnished for color that grows darker at each edge and corner. The collection is styled with high backs and square arms.

This collection features:

- Top grain leather. Variations in the characteristics and color are natural to the hide making each piece slightly unique.
- Heavy-gauge hand-tied coil steel springs
- Deluxe seat cushions feature a hypoallergenic down-blend wrap. Back cushions contain a deluxe hypoallergenic down-blend fill
- Kiln-dried hardwood frames

Built to last by expert craftsmen, each piece in the collection undergoes six quality control checkpoints where every component is inspected to ensure the highest standard of quality and structural integrity.

 a size for every space

WE'VE EXPANDED OUR FAVORITE UPHOLSTERY COLLECTIONS TO HAVE MORE SIZES & STYLES AVAILABLE:

- Three sofa sizes offered: love seat, sofa and grand sofa.
- More sectional configuration options than ever.

SOFAS



73.25" LOVE SEAT



85.5" SOFA



104.5" GRAND SOFA



82.25" SLEEPER SOFA

CHAIRS & OTTOMANS



SMALL ARMCHAIR



ARMCHAIR



SWIVEL ARMCHAIR



SMALL OTTOMAN



OTTOMAN



STORAGE OTTOMAN

POTTERY BARN

TURNER SQUARE ARM LEATHER COLLECTION

SECTIONALS



LEFT/RIGHT SOFA WITH CHAISE SECTIONAL



LEFT/RIGHT 3-PIECE SECTIONAL WITH CORNER



3-PIECE L-SHAPED SECTIONAL WITH CORNER



ARMLESS CHAIR



ARMLESS LOVESEAT

LEATHER OPTIONS



SADDLE



CRACKLED
WALNUT

Top Grain Leather. Variations in the characteristics and color are natural to the hide making each piece slightly unique.

DESIGN YOUR SPACE

FURNITURE SPECIFICATIONS

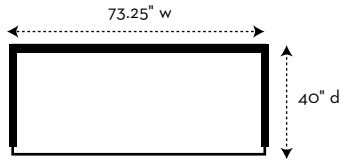

LOVE SEAT
35.5" high

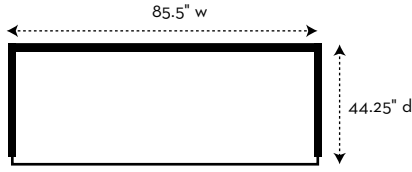

SOFA
35" high

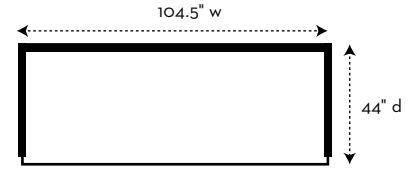

GRAND SOFA
35" high

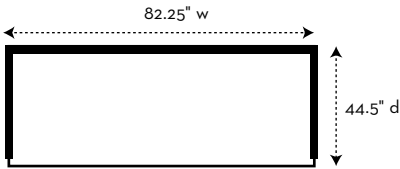

SLEEPER SOFA
35" high

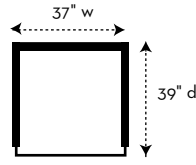

SMALL ARMCHAIR
36" high

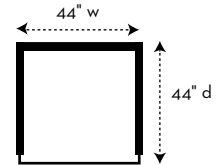

ARMCHAIR
35" high

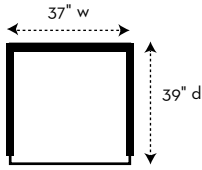

SWIVEL ARMCHAIR
35" high

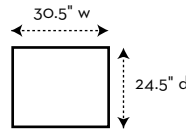

SMALL OTTOMAN
16.5" high

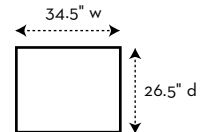

OTTOMAN
16.5" high

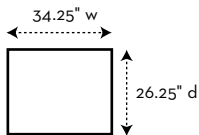

STORAGE OTTOMAN
16.75" high

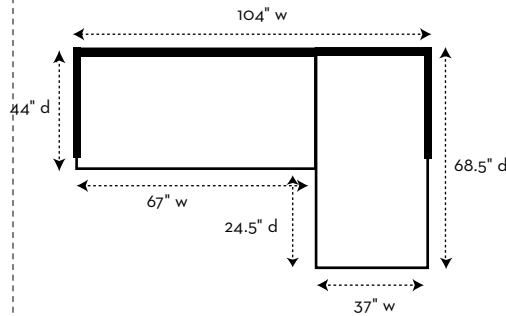

LEFT SOFA WITH CHAISE SECTIONAL
33.5" high
Consists of: Left Arm Love Seat, Right Arm Chaise

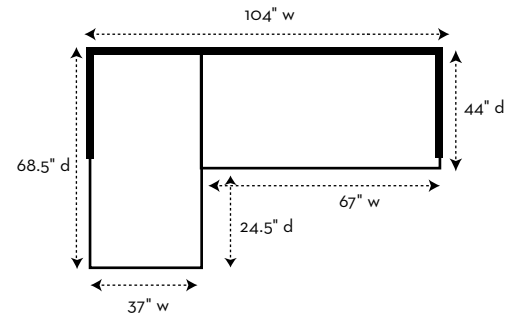

RIGHT SOFA WITH CHAISE SECTIONAL
33.5" high
Consists of: Right Arm Love Seat, Left Arm Chaise

POTTERY BARN

TURNER SQUARE ARM LEATHER COLLECTION

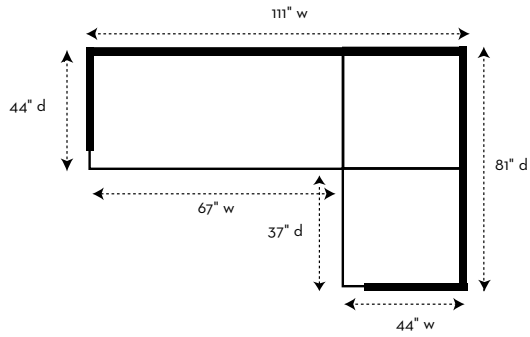

LEFT 3-PIECE SECTIONAL WITH CORNER
 35.5" high
 Consists of: Left Arm Love Seat, Corner, Right Arm Chair

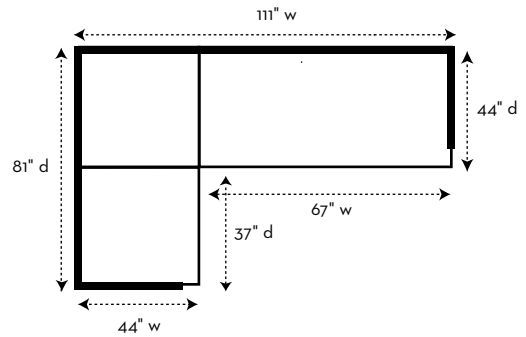

RIGHT 3-PIECE SECTIONAL WITH CORNER
 35.5" high
 Consists of: Right Arm Love Seat, Corner, Left Arm Chair

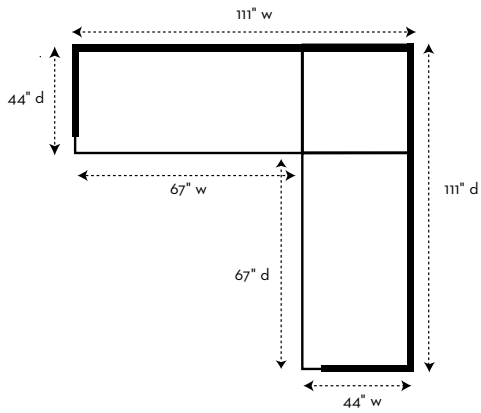

3-PIECE L-SHAPED SECTIONAL WITH CORNER
 35.5" high
 Consists of: Left Arm Love Seat, Corner, Right Arm Love Seat

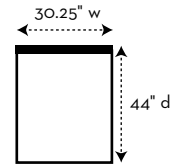

ARMLESS CHAIR
 35.5" high

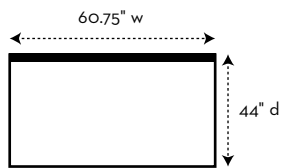

ARMLESS LOVE SEAT
 35.5" high

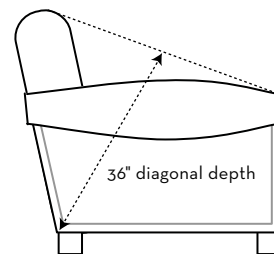

DIAGONAL DEPTH
 Diagonal depth is helpful when determining if a piece can be brought in on its end.

3 STEPS TO PREPARE FOR SUCCESSFUL FURNITURE DELIVERY

DELIVERY DIMENSIONS. DOES IT FIT INTO MY HOME?

Before purchasing large furniture, it's a must to take proper measurements of your space to ensure that the piece will not only sit comfortably in the room for which it is intended, but also fit through all of the passageways between the delivery truck and your new furniture's final destination. Use the measuring guidelines below for a successful delivery:

1 MEASURE YOUR SPACE

Identify the space in the room where you intend your piece to sit. Using painter's tape, mark out the dimensions on the floor. Does it fit? Is the scale right for the room? You can also create a floor plan using our online room planner.

Visit potterybarn.com and search: *room planner*

2 COMPARE THE DIMENSIONS OF YOUR RESIDENCE AND YOUR FURNITURE PIECE

Consider the furniture to be delivered and determine if it can go straight through entryways or if it will have to go in at an angle or on its end.

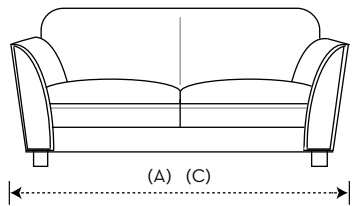

Sofa width must be less than entryway dimensions A or C.

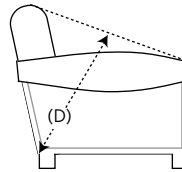

DIAGONAL DEPTH

Diagonal depth must be less than entryway dimension B. Diagonal depth is helpful when determining if the piece can be brought in on its end.

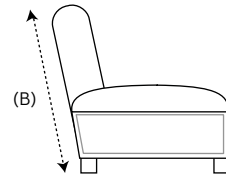

ARMLESS PIECE

For any piece that does not have arms (such as a wedge), do not use diagonal depth measurement. Instead, be certain that the back height measurement is less than the door width (B).

3 MEASURE ALL DOORWAYS, PASSAGES & STAIRWELLS

Measure the interior height and width of every doorway, staircase, elevator and hallway that the item will pass through. Also consider architectural details and low hanging fixtures as you measure.



We take great pride in our outstanding customer service and our in-home delivery service. In order to ensure complete satisfaction, please take the time to measure carefully before purchasing, and contact a Pottery Barn customer service representative with any additional questions. 1.888.779.5176 / customerservice@potterybarn.com

POTTERY BARN

UPHOLSTERED & SLIPCOVERED FURNITURE SHIPPING INFO

IN-HOME DELIVERY All of our upholstered furniture is delivered via our In-Home Delivery network. Most furniture items are opened and inspected prior to delivery to your home to ensure our quality expectations are met. On the day of delivery, we will bring the items into your home, place them in the room of your choice and complete any necessary assembly. Delivery is by appointment, Monday – Saturday; our delivery service will call to arrange a day and provide a 2–4 hour window for delivery. In-Home Delivery is available in the contiguous 48 states. Assembly is not available for headboard attachment to a non-Pottery Barn metal frame.

QUICK SHIP: 1-3 WEEKS Select items identified as Quick Ship will usually ship within 1 to 3 weeks for the cities shown on the map below. For other areas, your furniture will usually ship within 2 to 3 weeks.

SPECIAL ORDER: 8-10 WEEKS Special order items will usually ship within 8-10 weeks. We cannot accept returns on special order items. Please consider your order carefully.

STANDARD SHIPPING CHARGES

For orders totaling	Include	For orders totaling	Include
up to \$15.00	\$4.95	\$90.01 to \$125.00	\$17.00
\$15.01 to \$25.00	\$6.00	\$125.01 to \$200.00	\$21.00
\$25.01 to \$45.00	\$8.00	\$200.01 & over	10%
\$45.01 to \$65.00	\$11.00	\$3,000.01 & over	NOW 5%
\$65.01 to \$90.00	\$14.00		

ADDITIONAL SHIPPING AND DELIVERY SURCHARGES Because furniture items are bulky, heavy and may have limited availability, these items have an additional delivery and processing surcharge. This charge is listed in parentheses (\$) after the item price and is in addition to regular delivery and processing charges, which are listed under Standard Shipping Charges.

SALES TAX Sales tax on the merchandise total is charged for items shipped to the following states, US territories and the District of Columbia: AL*, AR*, AZ, CA*, CO*, CT*, DC*, FL*, GA*, IA, ID, IL*, IN*, KS*, KY*, LA*, MA, MD*, ME*, MI*, MN*, MO*, MS*, NC*, ND*, NE*, NJ*, NM*, NV*, NY*, OH*, OK, PA*, RI*, SC*, SD*, TN*, TX*, UT, VA*, VT*, WA*, WI*, WV*, WY and Puerto Rico*. States and US territories marked with an asterisk also collect taxes on shipping and processing charges. The local sales tax of the delivery destination is also charged. Sales tax for items shipped to Illinois is based on the location of final order acceptance. Orders delivered to California locations are F.O.B. destination point which means title passes in California.

RETURNS At Pottery Barn, we take great pride in the quality and craftsmanship of our products. Attention to design, materials and construction is our priority. We carefully inspect your order prior to shipment; upon receipt, please inspect your purchase and notify us of any damage. We will arrange for a prompt replacement. If, within 7 days for Quick Ship upholstery and 30 days for all other products, you are dissatisfied for any reason, you may return your purchase for a refund of the merchandise value. We cannot accept returns on special order items. Please consider your order carefully.

