



Carissa Chair
Chaise Carissa
Silla Carissa

⚠ ENGLISH

- Do not throw away packaging materials until assembly is complete.
- Assemble this item on a soft surface, such as cardboard or carpet, to protect finish.
- Proper assembly of this item requires 2 people.

⚠ FRANÇAIS

- Ne pas jeter les matériaux d'emballage avant la fin de l'assemblage.
- Assembler cet article sur une surface douce, telle qu'un carton ou un tapis.
- Deux personnes sont requises pour l'assemblage approprié de cet article.

⚠ ESPAÑOL

- No desechar los materiales del empaque hasta haber completado el ensamblaje.
 - Ensamblar este artículo en una superficie suave, como un cartón o una alfombra, para proteger el acabado.
 - El ensamblaje apropiado de este artículo requiere dos personas.
-

Care Instructions:

- Hardware may loosen overtime. Periodically check that all connections are tight. Wipe with a soft, dry cloth.
- To protect finish, avoid the use of chemicals and household cleaners. All hot serving dishes should be placed on a pad.
- Any liquid spilled onto the furniture should be cleaned up immediately with a damp cloth.



Instructions d'entretien :

- Épousseter régulièrement avec un chiffon propre, doux et non pelucheux.
- Éponger immédiatement les liquides renversés et essuyer à l'aide d'un chiffon propre et humide.
- L'utilisation de produits nettoyants chimiques, d'abrasifs ou d'encaustiques sur nos finitions laquées n'est pas recommandée.
- Le matériel de fixation peut se desserrer avec le temps. Vérifiez régulièrement afin de vous assurer que tous les raccords sont bien serrés. Resserrez-les au besoin.

Instrucciones de cuidado:

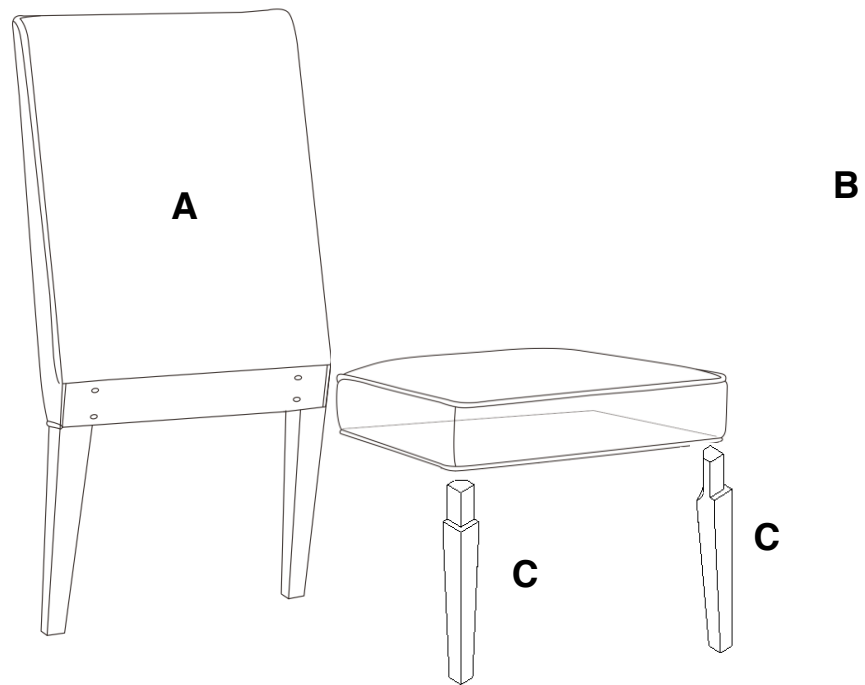
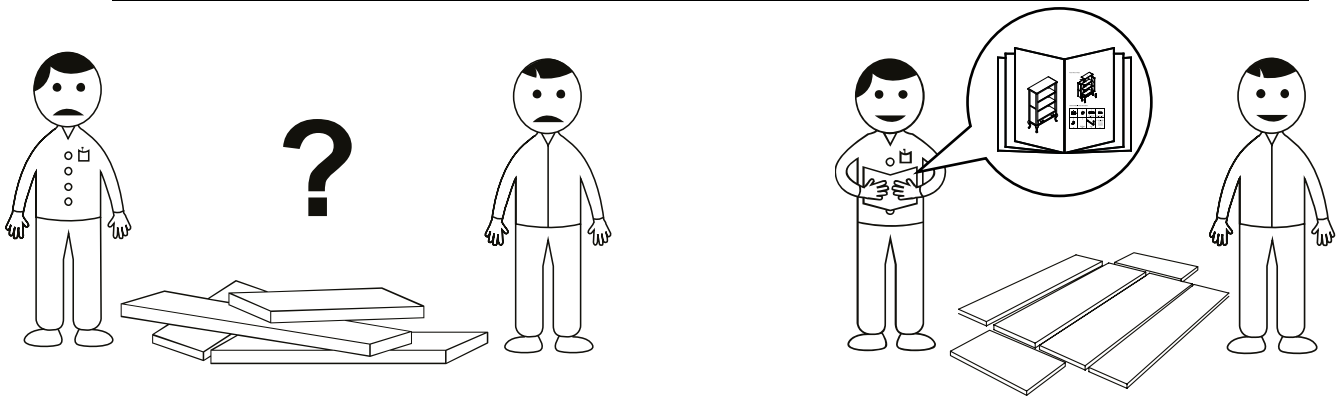
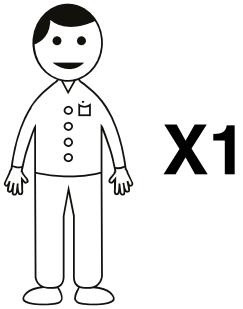
- Limpiar el polvo con un trapo limpio, suave, seco y libre de pelusas.
- Secar los derrames de inmediato y limpiar con un trapo limpio y húmedo.
- Recomendamos no usar limpiadores químicos, abrasivos o lustramuebles sobre el acabado barnizado.
- Las piezas de ferretería pueden aflojarse con el tiempo. Controlar periódicamente que estén bien ajustadas. Si es necesario, volver a ajustarlas.

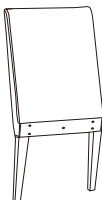
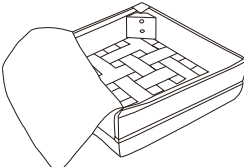
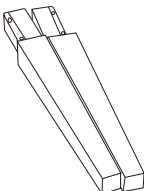

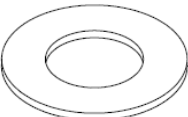
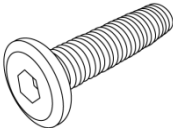
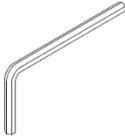
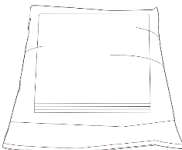
<p>A</p>  <p>1x</p>	<p>B</p>  <p>1x</p>	<p>C</p>  <p>2x</p>	<p>D</p>  <p>9x</p>
<p>E</p>  <p>9x</p>	<p>F</p>  <p>9x</p>	<p>G</p>  <p>8x</p>	<p>H</p>  <p>8x</p>

1

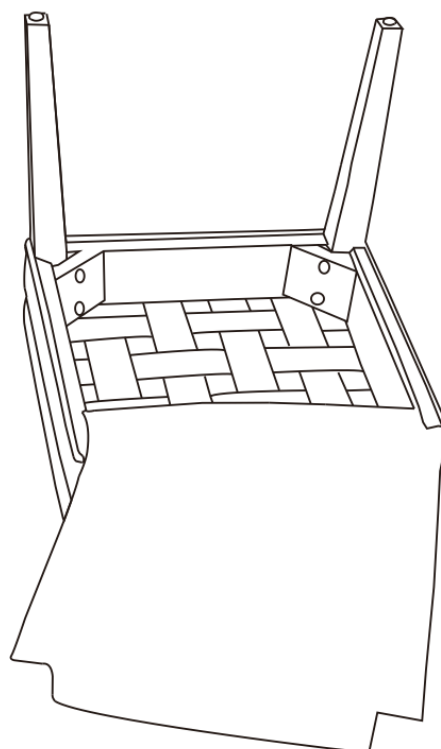
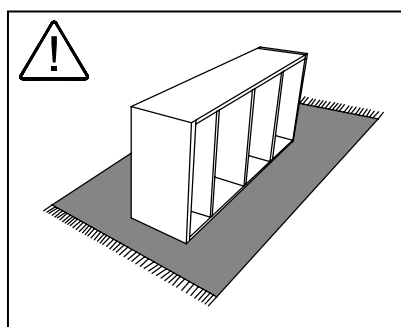

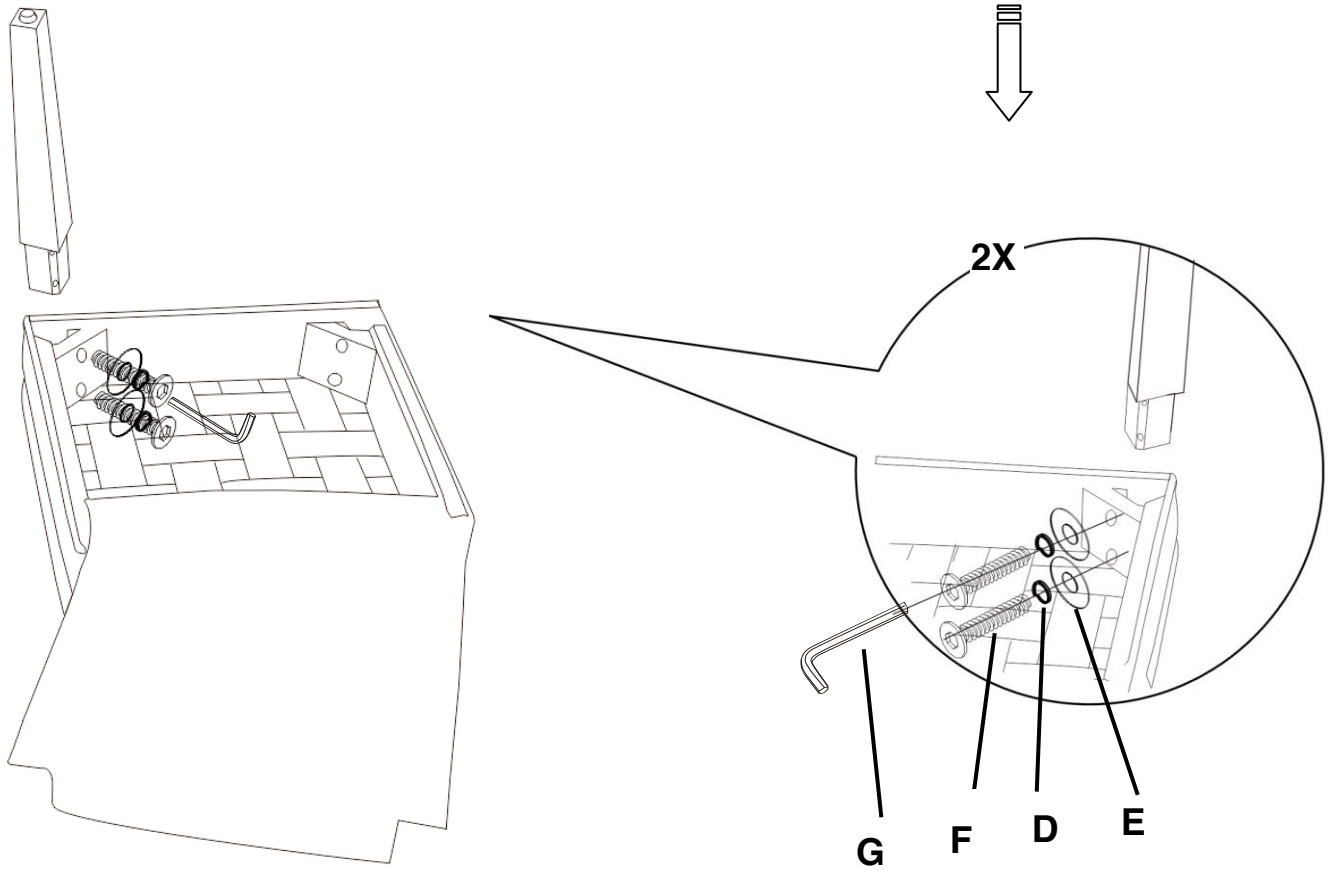

2

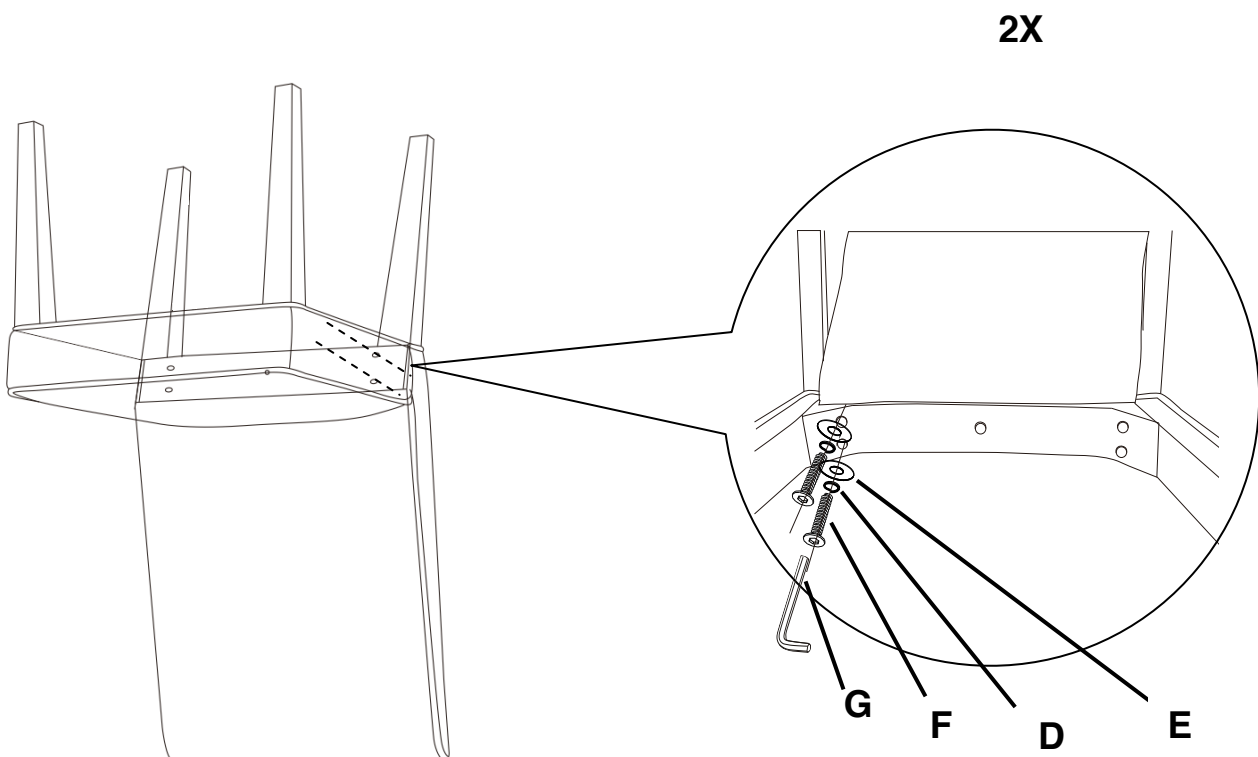

3

